











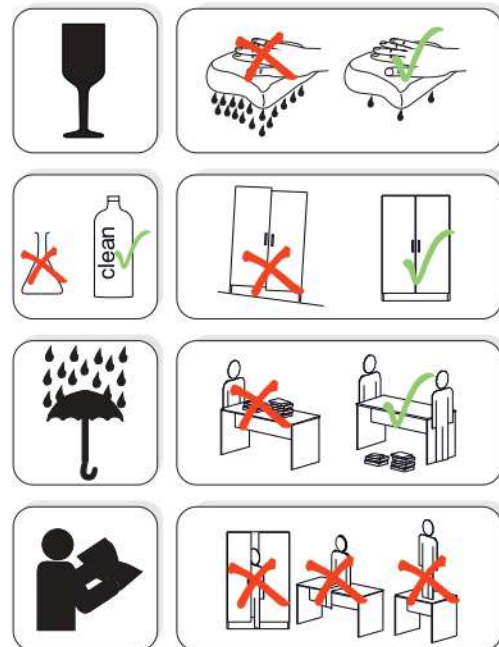
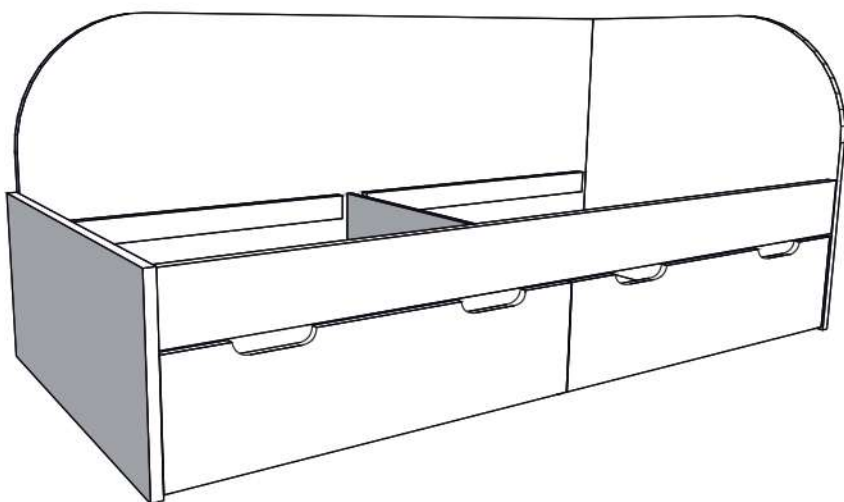
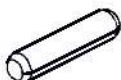





# REA GARY 90/120 (desna)

 2050  
 890  
 950/1250



1/1

1		2		3		4		5		6		7	
8x35	23X		21X		21X		8X		9X	M6x70	9X		6X
8		9		10		11		12		13		14	
1,2x25	12X		8X	3,5x16	28X	3,5x30	4X	7x50	8X	7x70	2X		6X

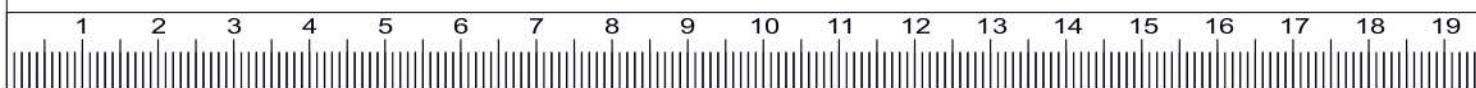
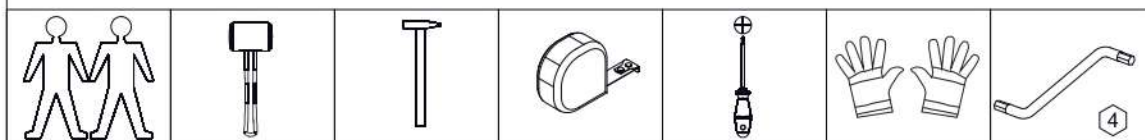

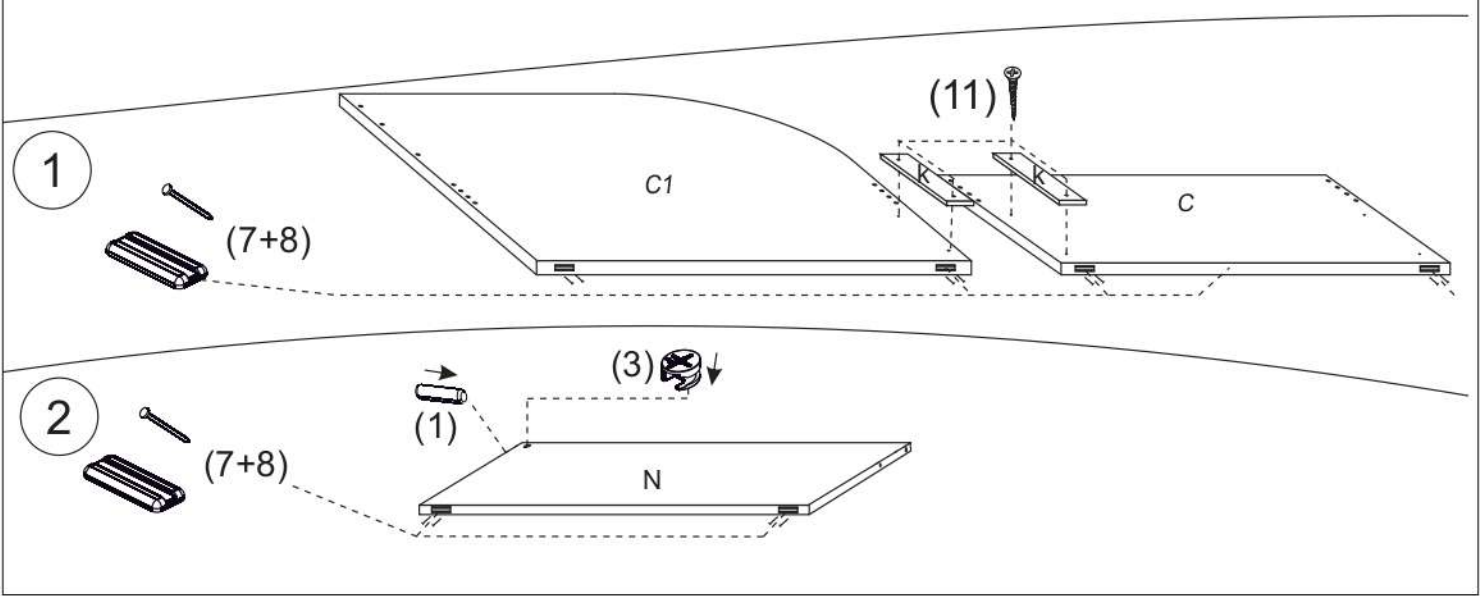
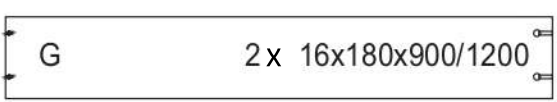
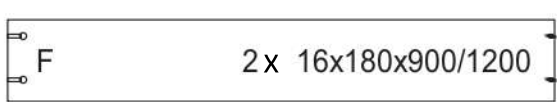
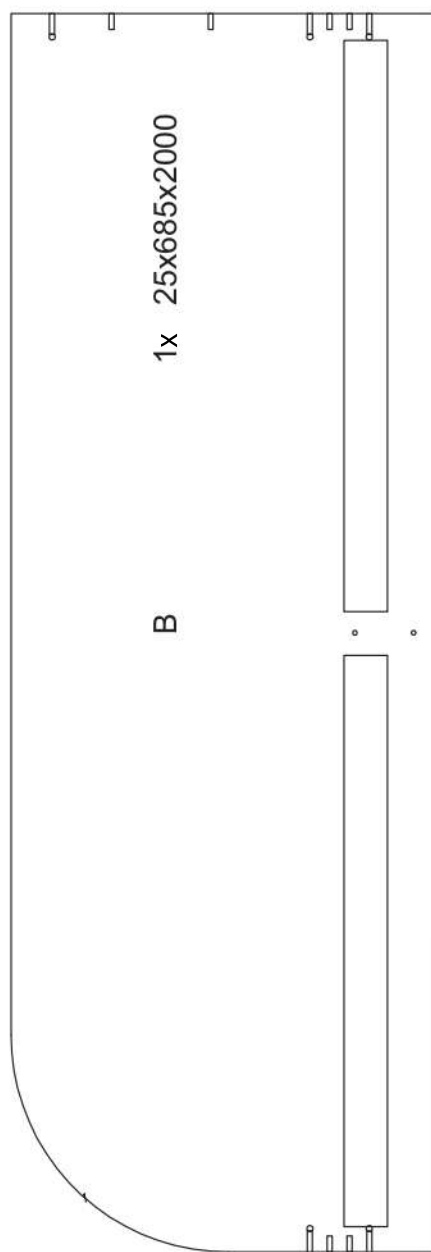
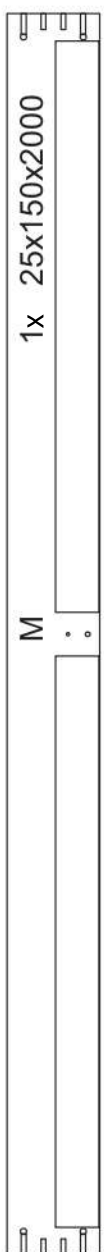
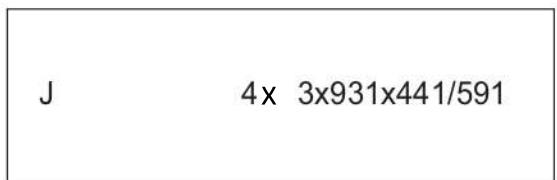
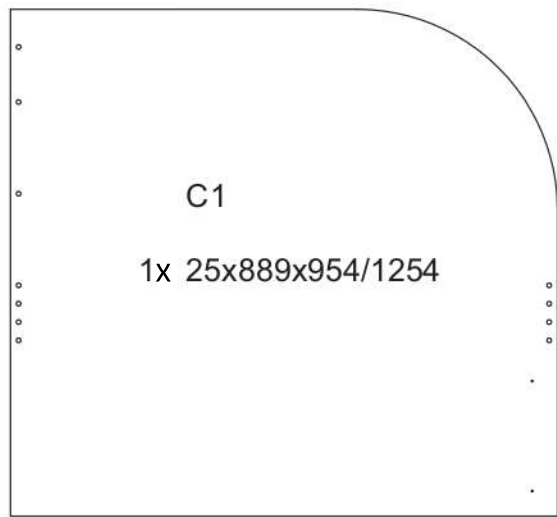
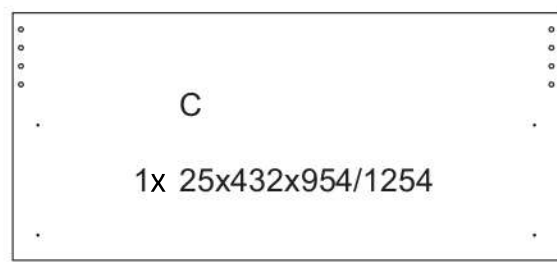

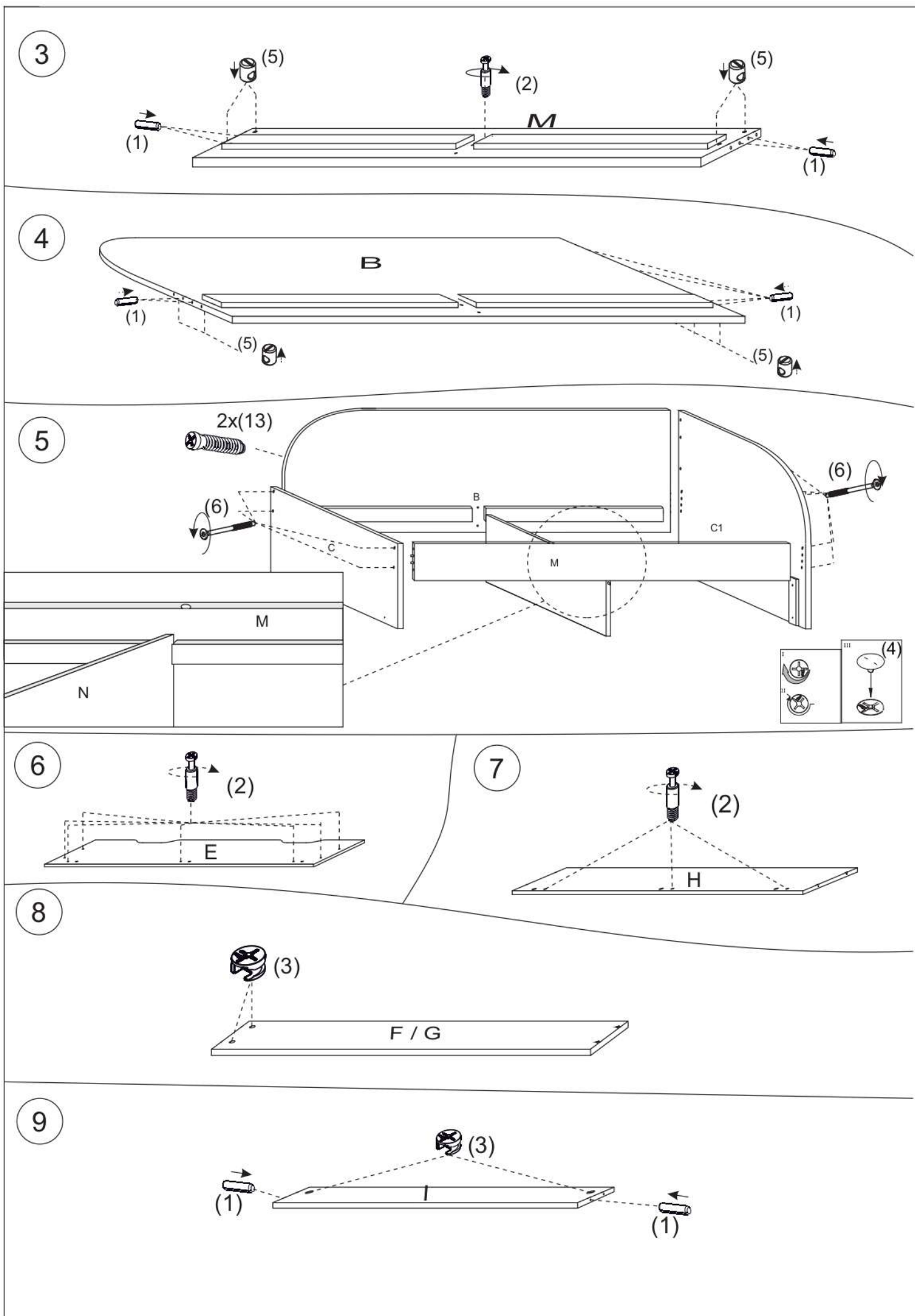

10

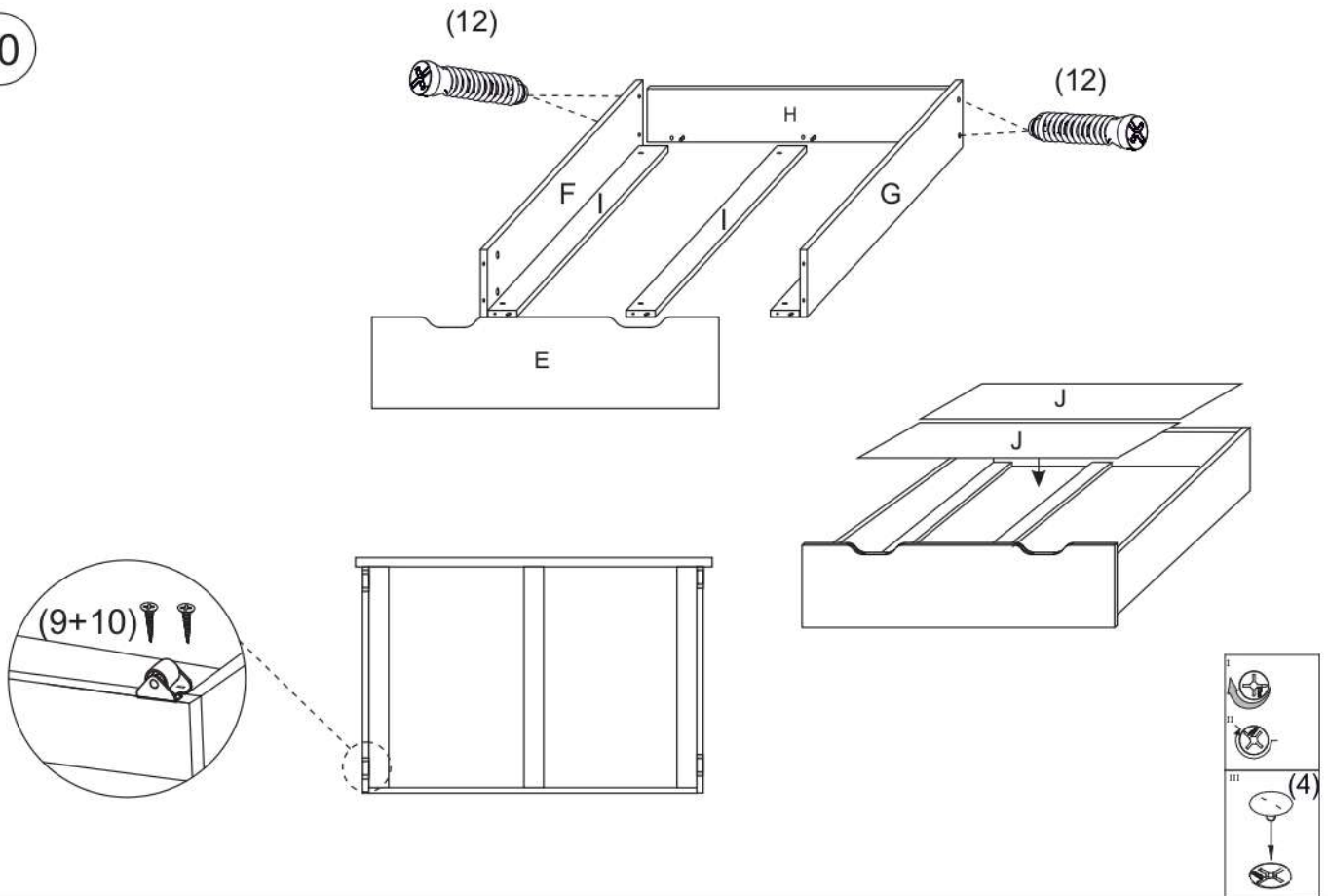

11

